

GEORGE FOREMAN[®]

HEALTHY LIVING

George Foreman

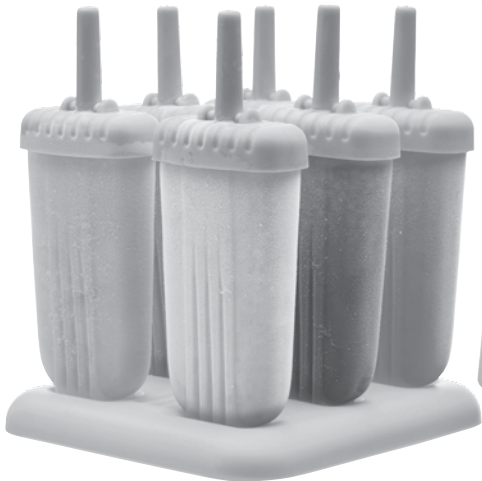

GEORGE FOREMAN[®]

MIX & GO BLEND & FREEZE

Instructions & Warranty

Spectrum Brands Australia Pty Ltd

Locked Bag 3004 Braeside
Victoria 3195 Australia

Customer Service in Australia

TollFree: 1800 623 118
Email: info@spectrumbrands.com.au
Website: www.spectrumbrands.com.au

Spectrum Brands New Zealand Ltd

PO Box 9817 Newmarket
Auckland 1149 New Zealand

Customer Service in New Zealand

TollFree: 0800 736 776
Email: service@spectrumbrands.co.nz
Website: www.spectrumbrands.co.nz

Spectrum Brands Australia Pty Ltd and Spectrum Brands New Zealand Ltd Warranty Against Defects



In this warranty:

Australian Consumer Law means the Australian consumer law set out in Schedule 2 to the Competition and Consumer Act 2010;

CGA means the New Zealand Consumer Guarantees Act 1993;

Goods means the product or equipment which was accompanied by this warranty and purchased in Australia or New Zealand, as the case may be;

Manufacturer, We or **us** means:

1. for Goods purchased in Australia, Spectrum Brands Australia Pty Ltd ABN, 78 007 070 573;
or
2. for Goods purchased in New Zealand, Spectrum Brands New Zealand Ltd, as the case may be, contact details as set out at the end of this warranty;

Supplier means the authorised distributor or retailer of the Goods that sold you the Goods in Australia or in New Zealand; and

You means you, the original end-user purchaser of the Goods.

1. Our goods come with guarantees that cannot be excluded under the Australian Consumer Law, or the CGA. You are entitled to a replacement or refund for a major failure and compensation for any other reasonably foreseeable loss or damage. You are also entitled to have the goods repaired or replaced if the goods fail to be of acceptable quality and the failure does not amount to a major failure.
2. The benefits provided by this Warranty are in addition to all other rights and remedies in respect of the Goods which the consumer has under either the Australian Consumer Law or the CGA. The original purchaser of the Goods is provided with the following Warranty subject to the Warranty Conditions:
3. We warrant the Goods for all parts defective in workmanship or materials from the date of purchase (**Warranty Period**), for the period of 1 year from the date of purchase (**Warranty Period**).

If the Goods prove defective within the Warranty Period by reason of improper workmanship or material, we may, at our own discretion, repair or replace the Goods without charge.

Warranty Conditions

4. The Goods must be used in accordance with the manufacturer's instructions. This Warranty does not apply should the defect in or failure of the Goods be attributable to misuse, abuse, accident or non-observance of manufacturer's instructions on the part of the user. As far as the law permits, the manufacturer does not accept liability for any direct or consequential loss, damage or other expense caused by or arising out of any failure to use the Goods in accordance with the manufacturer's instructions.
5. Exhaustible components (such as batteries, filters and brushes) of the Goods are included under this Warranty only where there is a defect in workmanship or materials used.
6. The warranty granted under clause 3 is limited to repair or replacement only.
7. Any parts of the Goods replaced during repairs or any product replaced remain the property of the manufacturer. In the event of the Goods being replaced during the Warranty Period, the warranty on the replacement Goods will expire on the same date as for the Warranty Period on the original Goods which are replaced.
8. In order to claim under the warranty granted under clause 3 you must:
 - (a) Retain this warranty with your receipt/proof of purchase; and
 - (b) Return the Goods to us at the relevant address or to the Supplier by prepaid freight within the Warranty Period accompanied with (i) the legible and unmodified original proof of purchase, which clearly indicates the name and address of the Supplier, the date and place of purchase, the product name or other product serial number and (ii) this warranty.
9. This warranty is immediately void if:
 - (a) Any serial number or appliance plate is removed or defaced;
 - (b) The Goods have been serviced or otherwise repaired by a person not authorised to do so by us or where non approved replaced parts are used.
10. The Goods are designed for domestic use only. The Goods must be connected to the electrical voltage requirements as specified in the ratings label located on the Goods.
11. This warranty does not cover the cost of claiming under the warranty or transport of the Goods to and from the Supplier or us.
12. This warranty is only valid and enforceable in Australia against Spectrum Brands Australia Pty Ltd and in New Zealand against Spectrum Brands New Zealand Ltd.

Contact us or the Supplier for further details.

Register your product online

If you live in Australia please visit: www.spectrumbrands.com.au/warranty

If you live in New Zealand Please visit: www.spectrumbrands.co.nz/warranty

Registration of your warranty is not compulsory, it gives us a record of your purchase AND entitles you to receive these benefits: Product information; Hints and tips; Recipes and news; Information on special price offers and promotions.

Any questions? Please contact Customer Service for advice.

IMPORTANT SAFEGUARDS

When using this appliance, basic safety precautions should always be followed, including the following:

Read all instructions before, and follow whilst using this appliance.

1. To protect against electric shock do not immerse cord, plug or blender base of unit in water or liquid of any sort.
2. Do not use outdoors.
3. Do not use in the bathroom or near any source of water.
3. This appliance is not intended for use by persons (including children) with reduced physical, sensory or mental capabilities, or lack of experience and knowledge, unless they have been given supervision or instruction concerning use of the appliance by a person responsible for their safety.
4. This appliance is NOT a toy. Children should be supervised to ensure they do NOT play with the appliance.
5. Cleaning or user maintenance shall not be carried out by children without the supervision of a person responsible for their safety.
6. Always turn off and unplug from the wall power outlet when not in use, before fitting or removing parts, and before cleaning the appliance.
7. To disconnect, ensure the appliance switch is set to off, turn off the wall power outlet, then grasp and pull the plug from the wall outlet. Never pull by the cord.
8. Do not operate this appliance with a damaged cord/plug or after the appliance has been dropped, damaged or has malfunctioned in any manner. Contact customer service for replacement, examination, repair or adjustment.
9. There are no user serviceable parts. If the power cord or appliance is damaged, it must be repaired or replaced by the manufacturer or a suitably qualified person in order to avoid hazard.
10. The use of attachments/accessories not recommended by the appliance manufacturer may cause injuries or damage to the appliance and void warranty.
11. Do not use on an inclined plane or unstable surface.
12. Keep the appliance and the power cord away from the edge of tables or countertops and out of reach of children and persons with reduced physical, sensory and mental capacities.
13. Before switching on, ensure the bottle has been assembled correctly and has been seated onto the motor unit. The motor will only operate if the bottle has been properly seated onto the motor unit.
14. Do not use the appliance if the rotating cones are damaged.
15. Care must be taken when handling any accessories with sharp edges. Cutting blades are very sharp. Handle with extreme care and caution when removing from the bottle and during cleaning.
16. Do not operate the appliance with an empty bottle.
17. Do not blend hot/warm ingredients - always allow to cool to room temperature before blending.
18. Wait until the blades come to a complete stop before removing the bottle from the motor unit.
19. Do not run the motor for longer than 2 minutes. After 2 minutes, switch off for at least a further 2 minutes to allow the motor to cool down.
20. Switch off and unplug the appliance before changing accessories or touching parts that move whilst in use.
21. Do not attempt to defeat any safety interlock mechanisms.
22. To prevent possible damage to the appliance do not use harsh abrasive or alkaline cleaning agents.
23. Always clean the appliance after use.
24. Follow the instructions when cleaning this appliance.
25. Do not place on or near any heat sources.
26. Misuse of the appliance may cause injury.
27. Do not leave the appliance unattended when in use.
28. Do not use appliance for other than its intended purpose.

29. This appliance is not intended to be operated by means of an external timer or separate remote control system.
30. For added safety, electrical appliances should be connected to a power outlet that is protected by a residual current device (RCD / 'Safety Switch') having a rated residual operating current not exceeding 30mA. Your switchboard may already incorporate an RCD. If unsure, call an electrician for verification and fitting if necessary.
31. This appliance is intended to be used in household and similar applications such as:
 - Staff kitchen areas in shops, offices and other working environments;
 - Farm houses;
 - By clients in hotels, motels, and other residential type environments;
 - Bed & breakfast type environments.

SAVE THESE INSTRUCTIONS

Congratulations on the purchase of your George Foreman Mix & Go Blend & Freeze. Each unit is manufactured to ensure safety and reliability. Before using the appliance for the first time, please read the instruction book carefully and keep it for future reference. Pass it on if you pass on the appliance.

When using electrical appliances, basic safety precautions should always be followed.

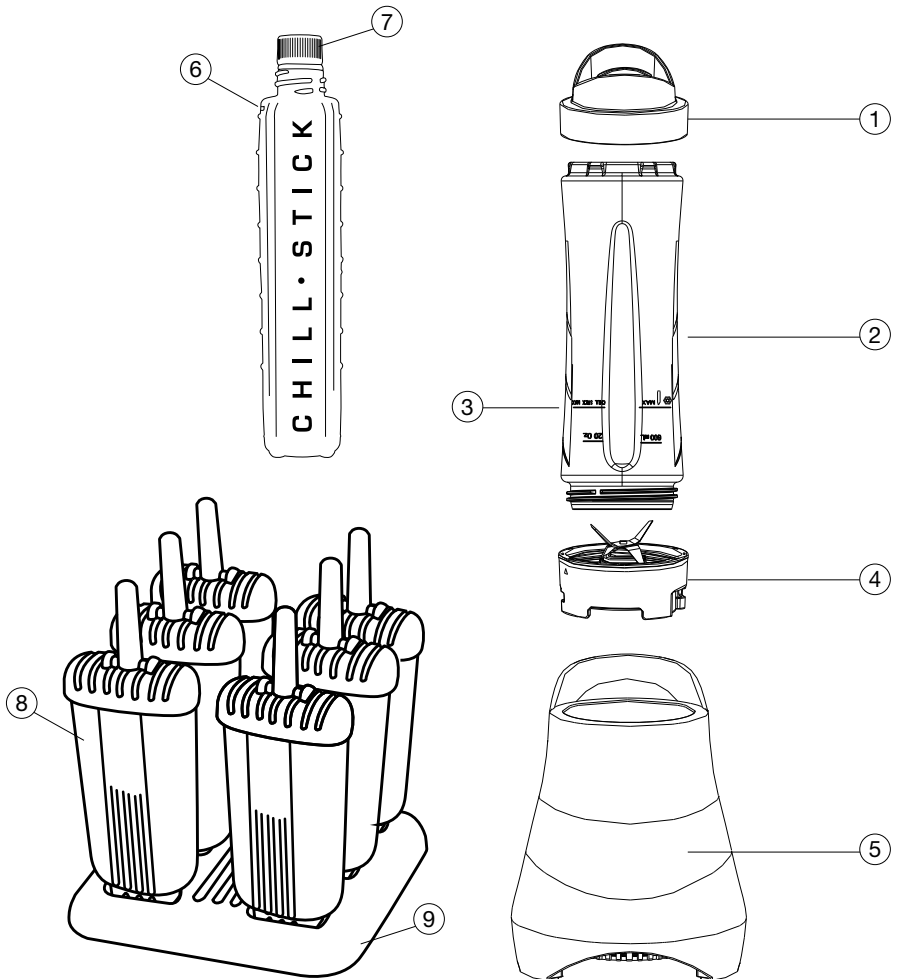

1. Drink Bottle Lid
2. Blender Bottle
3. MAX fill line when using Chill Stick
4. Blade Assembly
5. Blender Base
6. Chill Stick MAX fill line
7. Chill Stick lid
8. Frozen treat moulds
9. Frozen treat moulds base

BEFORE FIRST USE

CAUTION: Handle blades carefully.

- Remove all packaging material and any stickers from the product.
- As some parts may be packed separately, check to ensure all items have been unpacked before disposing of the packaging.
- Clean all parts as instructed in the CARE AND CLEANING section of this manual.
- Freeze the Chill Sticks in advance so these are ready for when you make a drink.
- Detach the Chill Stick from the drink bottle lid by rotating clockwise.
- Open the lid of the Chill Stick and fill to its max line with cool water. Never fill with hot liquids or solids.
- Close the lid and place in the freezer.

HOW TO USE

Note: Prior to use, the blender bottle should be dismantled and washed as instructed in the CARE AND CLEANING section of this manual.

- Sit the blender on a stable, level, dry surface.
- Plug the cord into a standard electrical outlet.
- Place the blender bottle on a flat surface with the open end facing up.
- Place foods to be blended into bottle, liquids first, then any solids.

Note: Be sure not to fill ingredients past the 600ml marking of the personal blending bottle. If using the Chill Stick, do not fill ingredients past the CHILL STICK MAX marking of the personal blending bottle.

CAUTION: Do not blend hot/warm ingredients - always allow to cool to room temperature before blending.

- Fasten the blade assembly on to the open end of the blender bottle and turn it in a clockwise direction until it is locked.
- Turn the bottle upside down & line up arrows on the blade assembly to the arrows on the blender base and place the blender bottle in the blender base.
- The blender will automatically begin as soon as the blender bottle is pushed down into the blender base.
- For hands free continuous blending, simply turn the bottle clockwise in the blender base.
- To stop blending simply remove your hand from the blender bottle or if you have locked the blender bottle into the base, turn it anti clockwise to release it.
- Once the blades have stopped rotating, pull the blender bottle out of the blender base & turn the bottle over and place on a flat surface.
- Take a Chill Stick from your freezer and attach to the recess on the underside of the drink bottle lid by rotating anti-clockwise.
- Replace the blade assembly with the drink bottle lid and Chill Stick attached.

HOW TO FREEZE YOUR HEALTHY FROZEN TREATS

- Combine all the ingredients in your Mix & Go Blender.
- Blend as per instructions on previous page until smooth and creamy.
- Pour liquid into moulds until the liquid reaches the base of the rim of the mould. Lock the handle in place.
- Freeze for 4-8 hours, or overnight if possible.

Note: the time it takes to freeze will differ depending on the contents and consistency of the liquid.

Note: Certain foods can cause discolouration of popsicle moulds. This will not affect the performance of the product.

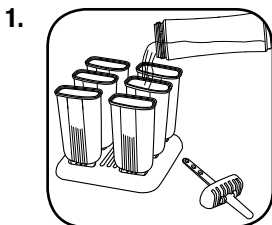

Fill moulds to the top

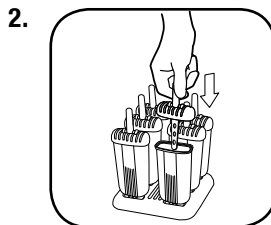

Gently lower stick into each mould

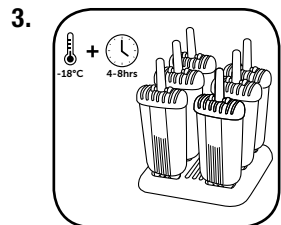

Freeze moulds for 4-8hrs

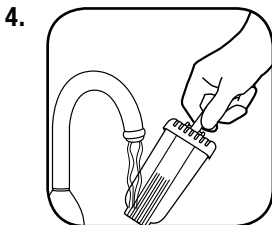

Run each mould under warm tap water

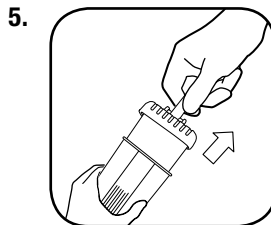

Gently pull frozen treat out of mould

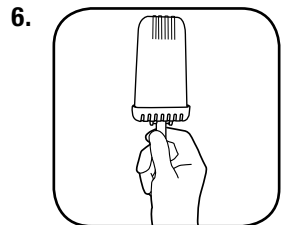

Enjoy!

BLENDING TIPS AND TECHNIQUES

- Put liquids in the blender bottle first, unless a recipe says otherwise. It is recommended you use at least 250ml of liquid for optimal results.
- Each mould holds 100ml of liquid while each blender bottle holds 600ml of liquid, so the contents of one full blender bottle will fill the 6 moulds.
- Cut all firm fruits and vegetables into pieces no larger than 1.8cm to 2.5cm. Ensure frozen solids are no larger than 2cm.
- Don't overload the bottle. If the motor stalls, turn the blender off immediately, unplug the unit and let it cool for at least 15 minutes.
- Then remove a portion of the food and continue.
- Never fill the Chill Sticks with hot liquids, solids or anything but cool water.

CAUTION: Do not blend hot/warm ingredients - always allow to cool to room temperature before blending.

TASKS NOT RECOMMENDED FOR THE BLENDER:

- Whipping cream
- Whipping egg whites
- Mixing dough
- Mashing potatoes
- Grinding meats

CARE AND CLEANING

This product contains no user serviceable parts. Refer service to qualified service personnel.

CLEANING

Caution: To prevent possible damage to the appliance do not use harsh abrasive or alkaline cleaning agents.

- Before cleaning, turn off and unplug appliance.
- Remove blade assembly from the blender bottle.
- Remove the rubber gasket from the blade assembly.

Caution: Blades are sharp, handle carefully.

- Place the bottle and all other bottle parts on the dishwasher top-rack only. Wash the popsicle moulds and popsicle base by hand with warm water and mild detergent.

Important:

- **Do not place bottle parts and moulds in boiling liquids.**
- **Do not immerse the motor unit in liquid. Wipe with damp cloth and dry thoroughly.**
- **Remove stubborn spots by rubbing with damp cloth and non-abrasive cleaner.**

Note: If liquids spill onto the motor unit, immediately disconnect cord from the power outlet & wipe with a damp cloth and dry thoroughly.

TO STORE

- Unplug the unit.
- Snap the drink bottle lid on the other end of the bottle to store.
- Ensure all parts are dry before storing the unit.

GEORGE FOREMAN®

HEALTHY COOKING



RECIPES

GEORGE FOREMAN® MIX & GO BLEND & FREEZE

WWW.GEORGEFOREMAN.COM.AU
WWW.GEORGEFOREMAN.CO.NZ

GEORGE FOREMAN and logo are trade marks of Spectrum Brands, Inc.,
or one of its subsidiaries.

©2016 Spectrum Brands, Inc.

WWW.GEORGEFOREMAN.COM.AU
WWW.GEORGEFOREMAN.CO.NZ

GEORGE FOREMAN and logo are trade marks of Spectrum Brands, Inc., or one of its subsidiaries.
©2016 Spectrum Brands, Inc.
Manufactured in China to Spectrum Brands specifications.

Recipes are to be used in conjunction with the GFBLP2 George Foreman Mix & Go Blend & Freeze.
All rights reserved. No part of this publication may be reproduced, stored in a retrieval system or transmitted in any form or by any means, electronic, mechanical, photocopying, recording or otherwise, without prior permission of the copyright owner.

BLENDER RECIPES

THE ZINGER

Ingredients:

- ½ apple, diced
- 1 orange, peeled and quartered
- 2 strawberries
- 1 kiwi fruit, peeled and quartered
- 1 handful spinach
- 1cm piece of ginger
- Juice of ½ a lemon
- 6 frozen raspberries

BANANARAMA

Ingredients:

- 1 banana
- 1 cup milk
- ½ cup vanilla yoghurt
- 1 tsp honey
- ¼ tsp nutmeg
- 2 ice cubes

TROPICAL SUNRISE

Ingredients:

- 1 orange, peeled & halved
- 6 strawberries
- ½ banana
- ½ cup frozen raspberries
- ½ cup chopped pineapple
- ½ cup water

BLENDER RECIPES

BREAKFAST POWER SMOOTHIE

Ingredients:

- 1 cup milk
- ½ cup frozen raspberries
- ½ cup natural yoghurt
- 1 ripe banana
- 1 egg
- 1 tbs *LSA mix (linseeds, sunflower seeds & almonds)
- 1 tbs honey

BERRY KALE JUICE

Ingredients:

- ½ cup frozen raspberries
- Handful of kale, 4 leaves
- 1 stick of celery
- 1 ripe pear, halved and cored
- 1 apple, halved and cored
- Juice of half a lemon
- 1cm piece of ginger
- 1 cup cold water

LEAN & GREEN

Ingredients:

- 2 leaves kale
- ½ lime, peeled
- 4 slices cucumber
- 2 kiwi fruit, peeled
- ¼ apple
- ½ cup baby spinach
- 1 cup water

BLENDER RECIPES

TROPICAL DELIGHT

Ingredients:

- ½ cup chopped rockmelon
- 1 mango cheek
- ½ cup chopped pineapple
- 1 pitted apricot, quartered
- 1 blood orange, peeled and quartered
- 1½ cups cold water

SUMMER MAGIC

Ingredients:

- 1 cup chopped rockmelon
- ½ banana
- 1 mango cheek
- 1 cup chopped pineapple
- 1 cup orange juice

SUMMER SUNSET

Ingredients:

- 1 cup chopped pineapple
- 4 ice cubes
- 1 cup chopped watermelon
- 1 cup orange juice

BERRY BONANZA

Ingredients:

- 1 cup chopped watermelon
- 4 strawberries, hulled
- ½ cup frozen blueberries
- ½ cup frozen blackberries
- 1 cup apple juice

BLEND & FREEZE RECIPES

METHOD:

1. Combine all the ingredients in your Mix & Go blender.
2. Blend until smooth and creamy.
3. Pour into frozen treat moulds and lock the lids in place.
4. Freeze for 4-8 hours, or overnight if possible.

MANGO LASSI TREATS

Ingredients:

- 1 cup diced mango flesh, fresh or frozen
- 1 cup milk
- ½ cup natural Greek-style yoghurt
- ½ teaspoon finely grated fresh ginger
- ½ teaspoon ground cardamom
- 2 teaspoons honey

Makes 6 frozen treats

BERRY & BANANA SMOOTHIE TREATS

Ingredients:

- 1 medium ripe banana
- 1 cup mixed berries, fresh or frozen
- 1 cup milk
- ½ cup natural Greek-style yoghurt
- drizzle of honey, (optional)

Makes 6 frozen treats

BLEND & FREEZE RECIPES

GREEN 'DETOX' SMOOTHIE TREATS

Ingredients:

Handful of baby spinach or kale leaves, washed

1 medium ripe banana, peeled

1 cup milk

2/3 cup chopped pineapple, kiwi fruit, apple, pear or cucumber

½ cup natural Greek-style yoghurt

5-6 fresh mint leaves

2 tsp lemon juice

½ teaspoon finely grated ginger

Makes 6 frozen treats